

ASSEMBLY INSTRUCTION INSTRUCTIONS D'ASSEMBLAGE

MODEL / MODELE: C0306B-050 (SILAC0MR)
DRESSER & MIRROR /
COMMODE & MIROIR

Caution: Please read instructions thoroughly before unpacking assembly parts. Sharp, exposed staple tips can cause injury, therefore, for your protection, please remove any exposed staple used in packing./ Attention : Lire toutes les instructions avant de débarrasser les pièces. Les agrafes en partie dé couvertes peuvent être dangereuses. Retirer de l'emballage toutes les agrafes présentant un risque.

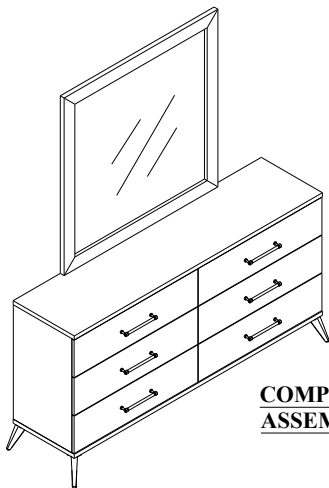

1. We recommend that you should assemble this product with the assistance of another person: this will make assembly easier and will help to eliminate damage to the product or injury to persons during assembly./ 1. Monter ce produit avec l'aide d'une seconde personne pour faciliter l'assemblage, protéger le produit et éviter tout risque de blessure.
2. Be sure to check all packing materials carefully for small parts that may have come loose inside the carton during shipment./ 2. Vérifier tous les paquets d'emballage. Certaines petites pièces peuvent s'être échappées de leur emballage durant le transport.
3. Please do not over tighten screws or bolts until the assembly is complete./ 3. Ne pas serrer trop les vis et boulons avant que l'assemblage sera terminé.
4. Please put all parts on a non-abrasive floor before assembly, and follow the assembly steps to assemble your newly purchased product correctly and efficiently./ 4. Pour un résultat optimal, disposer tous les éléments sur une surface non-râpeuse avant l'assemblage, et suivre chaque étape du montage avec attention.





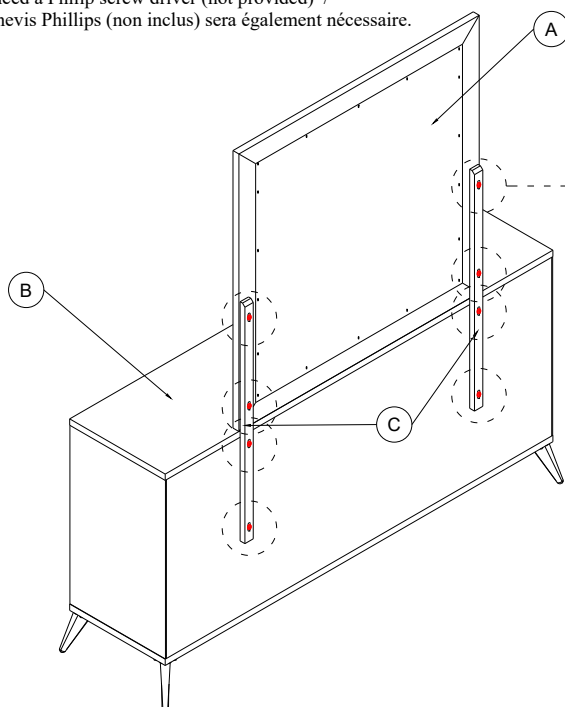

**COMPLETE ASSEMBLY /
ASSEMBLAGE TERMINE**

NOTE: You will also need a Philip screw driver (not provided) /
REMARQUE: un tournevis Phillips (non inclus) sera également nécessaire.



| PARTS IDENTIFICATION / IDENTIFICATION DE PIÈCES | | | |
|--|--|--|-------------------|
| A. |  | MIRROR / MIROIR | 1 PC / 1 PCE |
| B. |  | DRESSER / COMMODE | 1 PC / 1 PCE |
| C. |  | MIRROR SUPPORT RAIL / RENFORT DU MIROIR | 2 PCS / 2 PCES |

| HARDWARE LIST / QUINCAILLERIE | | | | |
|-------------------------------|--|---------------------------------------|-----------|-------------------|
| 1. |  | JCBB BOLT / BOULON JCBB | M6 x 40mm | 8 PCS / 8 PCES |
| 2. |  | SPRING WASHER / RONDELLE A RESSORT | M6 | 8 PCS / 8 PCES |
| 3. |  | FLAT WASHER / RONDELLE PLATE | M6 | 8 PCS / 8 PCES |
| 4. |  | ALLEN KEY / CLÉ ALLEN | M4 | 1 PC / 1 PCE |

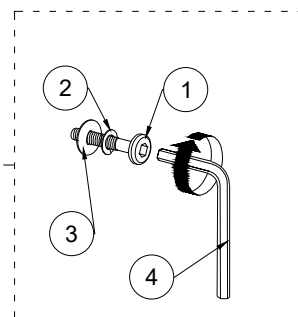

STEP 1 / ÉTAPE 1

Fix mirror on top of dresser. Insert JCBC bolt (1) into the holes at the mirror support. Tighten the support rail to the mirror & dresser with JCBC bolt (1) using Allen key (4). /
Fixer le miroir sur le commode. Insérer Boulon JCBC (1) dans les barres de soutien. Serrer les barres au miroir et au commode en utilisant les Boulons JCBC (1) à l'aide de la clé allen (4).

NOTE: MUST TIGHTEN SCREWS PERIODICALLY WITH USE SCREW WILL BECOME LOOSE CHECK TIGHTNESS OF ALL SCREW EVERY 6-8 WEEK. /
REMARQUE: RESERRER LES VIS RÉGULIÈREMENT. À L'USAGE, LES VIS SE DESERRENT. VÉRIFIER QUE LES VIS SOIENT SERRÉES TOUTES LES 6-8 SEMAINES.